

Diritti riservati All rights reserved

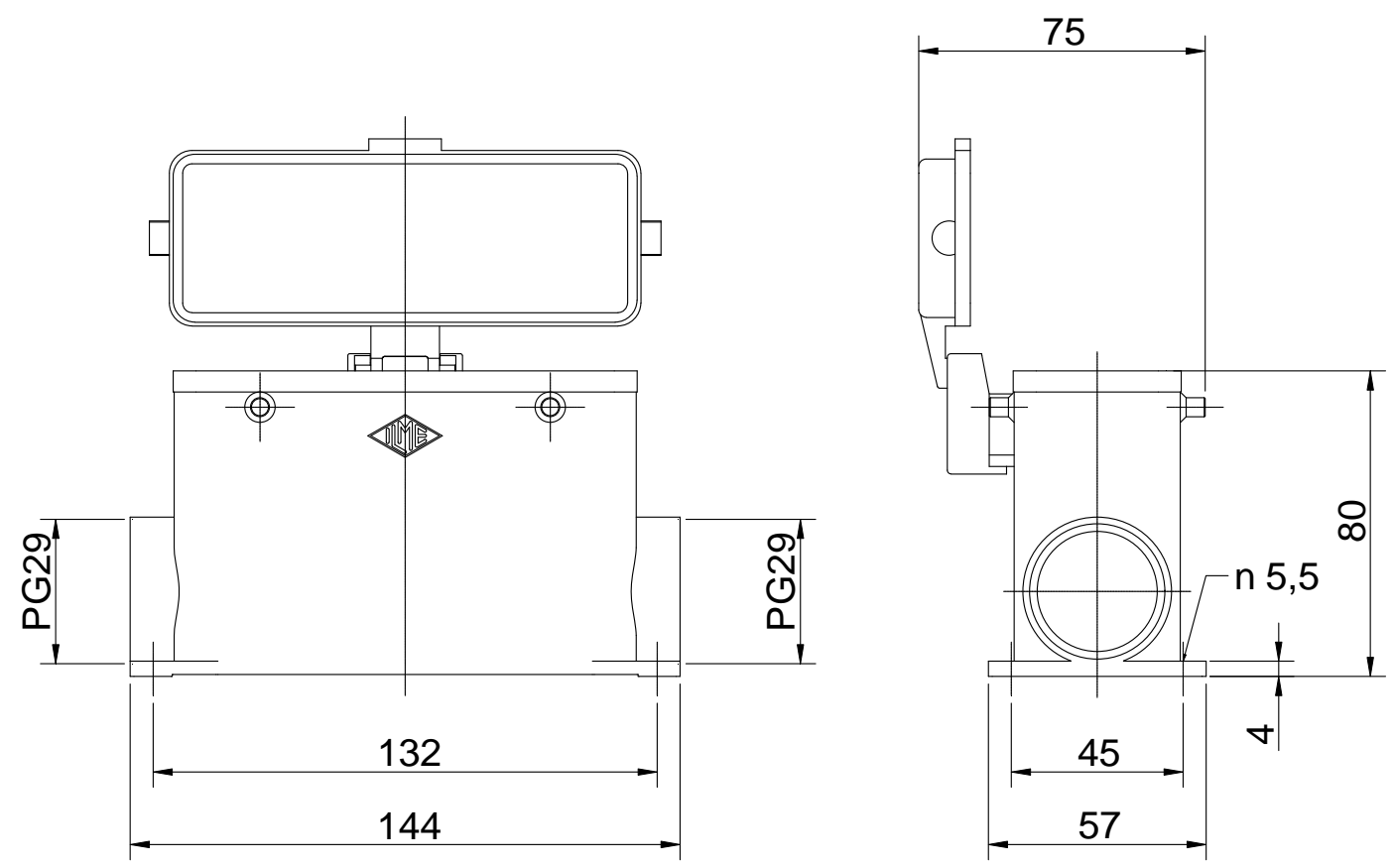

Date 04.01.2007	CMAP 16CP229		Scale
Sign.	surface mount.h.pegs, cov.2xPG29 ins.		1:2
			